

# MS25

## motor protection circuit breakers

Motor protection circuit breakers are special type of circuit breakers designed for protection of wide range of single-phase and three-phase ac motors against overload and short circuit. They are used in industry, small machines, agricultural machines, compressors etc.



### For motor protection

- ▶ All kind of AC induction motors
- ▶ For three-phase motors up to 22 kW

### Protection of other loads

- ▶ Various low-inductive loads
- ▶ Version with a thermal overload release for single-phase consumers MST20
- ▶ Version with thermal and magnetic release for single-phase consumers MS20
- ▶ Version for short-circuit protection MSZ25
- ▶ Version for transformer protection MS25TR

### Other Benefits

- ▶ Manual control:
  - START, STOP, push-buttons - Test of release function (TEST)
- ▶ Automatic switch-off at over-current with thermal or magnetic release
- ▶ Control with under-voltage release or shunt release
- ▶ An auxiliary switch for side mounting or flush mounting used for indication of the switching state
- ▶ Indication of release with trip indicating auxiliary switch
- ▶ ON/OFF buttons positions unequivocally indicates switching position of main contacts
- ▶ Contact material :
  - resistant to contact welding
  - enables low contact heating
- ▶ Isolating distance between contacts: 4.5 mm per contact place
- ▶ Connection of a rigid or flexible conductor
- ▶ Assembly to 35 mm wide mounting rail in compliance with EN 60715
- ▶ Vertical or horizontal operational position
- ▶ As required by IEC 60947-1, the manual motor starter features a trip-free mechanism. This means that the manual motor starter trips even if the handle is locked in the "ON" position or held by hand.

MS25 characteristics

Technical data	Symbol	Unit	MS25	MST25	MS20	MPE	MSZ25	MS25TR
<b>General</b>								
Area of use			motor protection IEC/EN 60947-4-1, IEC/EN 60947-2, IEC/EN 60204, UL 60947, CSA 22.2 No. 14		single-phase consumer	single-phase AC motors with built-in thermal switch	short-circuit protection	transformer protection
Standards					IEC/EN 60947-2, IEC/EN 60947-4-1	IEC/EN 60947-2, IEC/EN 60947-4-1	IEC/EN 60947-2	IEC/EN 60947-2
Approvals			CE, UL, EAC		CE, EAC		CE	
Climatic class					Constant damp heat acc. to IEC 60068-2-78 Cyclic damp heat acc. to IEC 60068-2-30			
Degree of protection					IP20, after terminals covering IP40			
Mounting					35 mm DIN rail (EN 60715)			
Mounting position					any			
Ambient temperature		°C			-25 ... +60			
Storage temperature		°C			-25 ... +70			
Temperature range of thermal compensation		°C			-5 ... +40			
Maximum altitude (MSL)*		m			2000			
Mechanical endurance		op. c.			100.000			
Electrical endurance		op. c.	100.000 (AC-3), 20.000 (DC-5)			100.000 (AC-3)		20.000 (DC-5)
Trip class acc. to IEC 60947-4-1				10A			/	10A
Utilization category acc. to IEC 60947-4-1			AC-3, DC-5			AC-3		AC-3, DC-5
Utilization category acc. to IEC 60947-2						A		
Max. switching frequency		op. c./h				25		
Shock resistance acc. to IEC 68-2-27		g				20		
Vibration resistance acc. to IEC 68-2-6		g			5 (at f= 5 ... 150 Hz)			
Overvoltage category						III		
Pollution degree						3		
Rated insulation voltage	$U_i$	V	690	400	690	250	400	690
Rated impulse withstand voltage	$U_{imp}$	kV				6		
Weight		g				252		
<b>Main circuit</b>								
<b>Terminal capacity</b>								
						1 ... 6		
						1 ... 4		
						0.75 ... 4		
Conductor insulation stripping length		mm				10		
Screw						M3		
Screw type						PZ2, with self-lifting clamp protected from falling out		
Tightening torque		Nm				1.8		
Nominal current	$I_n$	A	0.16, 0.25, 0.4, 0.63, 1, 1.6, 2.5, 4, 6.3, 10, 16, 20, 25	0.4, 0.63, 1, 1.6, 2.5, 4, 6.3, 10, 16, 20, 25	0.16, 0.25, 0.4, 0.63, 1, 1.6, 2.5, 4, 6.3, 10, 16, 20, 25	0.4 ... 10	0.16, 0.25	2.5, 4, 6.3, 10, 16, 20, 25
Current setting	$I_T$	A	0.1-0.16, 0.16-0.25, 0.25-0.4, 0.4-0.63, 0.63-1, 1-1.6, 1.6-2.5, 2.5-4, 4-6.3, 6.3-10, 10-16, 16-20, 20-25	0.25-0.4, 0.4-0.63, 0.63-1, 1-1.6, 1.6-2.5, 2.5-4, 4-6.3, 6.3-10, 10-16, 16-20, 20-25	0.1-0.16, 0.16-0.25, 0.25-0.4, 0.4-0.63, 0.63-1, 1-1.6, 1.6-2.5, 2.5-4, 4-6.3, 6.3-10, 10-16, 16-20, 20-25	fixed	fixed	2.5-4, 4-6.3, 6.3-10, 10-16, 16-20, 20-25
Nominal current range	$I_n$	A	0.16 ... 25	0.4 ... 25	0.16 ... 20	0.4 ... 10	0.16 ... 0.25	2.5 ... 25
Nominal frequency	f	Hz			50/60			
Max. operational voltage	$U_e$	V	690	400	690	250	400	690
Thermal current	$I_{th}$	A	25**		20**	10	0.25	25

### MS25 characteristics

Technical data	Symbol	Unit	MS25	MST25	MS20	MPE	MSZ25	MS25TR
<b>Main circuit</b>								
Max. motor current AC-3		A	25		20		/	
Max. motor current DC-5 (max. 250 V DC, all poles in series)		A	25		20		0.25	25
Number of all poles			3			1		3
Number of protected poles			3			1		3
Contact gap (per pole)		mm				9.5		
Release type			thermal-magnetic	thermal		thermal-magnetic	thermal	thermal-magnetic
Operating current of thermal overload release			1.05 I <sub>r</sub> < I < 1.2 I <sub>r</sub>				/	1.05 I <sub>r</sub> < I < 1.2 I <sub>r</sub>
Operating current of magnetic release (fixed)			14 I <sub>n</sub> ± 20 %			14 I <sub>n</sub> ± 20 %		20 I <sub>n</sub> ± 20 %
Sensitivity to phase failure			yes			/		yes
Power dissipation at I <sub>n</sub> (all poles)		W	6 ... 7.5		4 ... 5	2 ... 2.5	≈ 0.5	6 ... 7.5

Note: Above 2000 m voltages U<sub>i</sub> and U<sub>e</sub> are reduced by 2% for every 100 and current I<sub>e</sub> by 2% for every 500 m  
Maximum number of MPCBs mounted close together: 3

### MS25 motor protection switches

Rated ultimate and service short-circuit breaking capacity I and max. back-up fuses if short circuit current I exceeds I<sub>cu</sub>

Type	Max. back-up fuse U <sub>e</sub> < 400 V gL (A)
MST25 - 0.4	1
MST25 - 0.63	2
MST25 - 1	2
MST25 - 1.6	4
MST25 - 2.5	6
MST25 - 4	16
MST25 - 6.3	20
MST25 - 10	25
MST25 - 16	35
MST25 - 20	50
MST25 - 25	50
MST25 - 32	50

Type	Symbol	Unit	MS25	MST25	MS20	MPE	MSZ25	MS25TR
<b>Safety</b>								
MTTF - Mean time to failure MTTF = 1/λ = B10/(0.1 n <sub>op</sub> )		h				1666		
MTTF <sub>d</sub> - Mean time to failure dangerous MTTF <sub>d</sub> = 1/λ <sub>d</sub> = B10 <sub>d</sub> /(0.1 n <sub>op</sub> )		h				5000		
B10 - Number of operating cycles until 10 % of devices fail		op.				20.000		
B10 <sub>d</sub> - Number of operating cycles until 10 % of device dangerous B10 <sub>d</sub> = B10/ratio of dangerous failures		op.				60.000		
λ - Failure rate λ = (0,1 n <sub>op</sub> )/B10		1/h				6 × 10 <sup>-4</sup>		
λ - Failure rate dangerous λ <sub>d</sub> = (0,1 n <sub>op</sub> )/B10 <sub>d</sub>		1/h				2 × 10 <sup>-4</sup>		
Ratio of dangerous failures		%				33		
n <sub>op</sub> - Operating cycles (operating cycles/h)		op./h				120		

Switch selection for motor protection

Single-phase	Standard motor powers					Settings range
	Three-phase					
220 V 230 V 240 V	220 V 230 V 240 V	380 V 400 V	440 V	550 V	660 V 690 V	A
kW						
		0.02			0.06	0.1 ... 0.16
		0.06	0.06	0.06	0.09	0.16 ... 0.25
	0.06	0.09	0.12	0.12	0.18	0.25 ... 0.4
	0.09	0.12	0.18	0.25	0.25	0.4 ... 0.63
0.06 ... 0.09	0.09 ... 0.12	0.18 ... 0.25	0.25	0.37	0.37 ... 0.55	0.63 ... 1
0.12	0.18 ... 0.25	0.37 ... 0.55	0.37 ... 0.55	0.55 ... 0.8	0.75 ... 1.1	1 ... 1.6
0.18 ... 0.25	0.37	0.75 ... 1.1	0.75 ... 1.1	1.1	1.5	1.6 ... 2.5
0.37	0.55 ... 0.75	1.1 ... 1.5	1.5	1.5 ... 2.2	2.2 ... 3	2.5 ... 4
0.55 ... 0.75	1.1 ... 1.5	2.2 ... 2.5	2.2 ... 3	3	4	4 ... 6.3
1.1 ... 1.5	1.5 ... 2.5	3 ... 4	4 ... 5	4 ... 5.5	5.5 ... 7.5	6.3 ... 10
2.2	3 ... 4	5 ... 7.5	5.5 ... 9	7.5 ... 9	11	10 ... 16
3	5.5	9	11	11 ... 12.5	15	16 ... 20
	5.5 ... 7.5	11 ... 12.5	12.5	15	18.5	20 ... 25
	7.5	15	15	18.5	22	25 ... 32

MS25 motor protection switches

Rated ultimate and service short-circuit breaking capacity  $I_{cu}$  and  $I_{cs}$  and max. back-up fuses if short circuit current  $I_{cp}$  exceeds  $I_{cu}$

Type	Operating current of short-circuit release (A)	Rated ultimate short-circuit breaking capacity $I_{cu}$ , $I_{cs}$ (kA)				Max. back-up fuse, if $I_{cp} > I_{cu}$ (gL) (A)			
		230 V	400 V	500 V	690 V	230 V	400 V	500 V	690 V
		$I_{cu}$	$I_{cu}$	$I_{cu}$	$I_{cu}$				
MS25 - 0.16	2.2	50	50	50	50				
MS25 - 0.25	3.5	50	50	50	50				
MS25 - 0.4	6	50	50	50	50				
MS25 - 0.63	9	50	50	50	50	No back-up fuse required			
MS25 - 1	14	50	50	50	50				
MS25 - 1.6	23	50	50	50	50				
MS25 - 2.5	35	50	50	3	2.5			25	20
MS25 - 4	56	50	50	3	2.5			35	25
MS25 - 6.3	88	50	50	3	2.5			50	35
MS25 - 10	140	50	6	3	2.5		80	50	35
MS25 - 16	224	10	6	2.5	2	80	80	63	35
MS25 - 20	280	10	6	2.5	2	80	80	63	50
MS25 - 25	350	10	6	2.5	2	80	80	63	50
MS25 - 32	450	10	6	2.5	2	80	80	63	50

Motor protection circuit-breakers areas of use

Type	Motor protection	Overload protection	Short-circuit protection	Single-phase consumers	Transformer protection
MS25	•	•	•	•	
MST25	•	•		•	
MS20	•	•	•	•	
MS25TR		•	•		•
MSZ25			•	•	
MPE				•	

### Motor protection circuit breakers MS25

With overload and short-circuit release AC-3 acc. to IEC/EN 60947-4-1

Type	Setting range (A)	Motor power (3-phase, 400 V) (kW)	Ordering No.	Weight (g)	Packaging (pcs)
MS25-0.16	0.1 ... 0.16	0.02	30.107.955	252	1
MS25-0.25	0.16 ... 0.25	0.06	30.107.956	252	1
MS25-0.4	0.25 ... 0.4	0.09	30.107.957	252	1
MS25-0.63	0.4 ... 0.63	0.12	30.107.958	252	1
MS25-1	0.63 ... 1	0.18 ... 0.25	30.107.959	252	1
MS25-1.6	1 ... 1.6	0.37 ... 0.55	30.107.960	252	1
MS25-2.5	1.6 ... 2.5	0.75 ... 1.1	30.107.961	252	1
MS25-4	2.5 ... 4	1.1 ... 1.5	30.107.962	252	1
MS25-6.3	4 ... 6.3	2.2 ... 2.5	30.107.963	252	1
MS25-10	6.3 ... 10	3 ... 4	30.107.964	252	1
MS25-16	10 ... 16	5 ... 7.5	30.107.965	252	1
MS25-20	16 ... 20	9	30.107.966	252	1
MS25-25	20 ... 25	11 ... 12.5	30.107.967	252	1
MS25-32	25 ... 32	15	30.109.475	252	1



### Motor protection circuit breakers for single-phase consumers MS20

With overload and short-circuit release, AC-3 acc. to IEC/EN 60947-4-1

Type	Setting range (A)	Motor power (single-phase, 220-240 V) (kW)	Ordering No.	Weight (g)	Packaging (pcs)
MS20-0.16	0.1 ... 0.16	-	30.108.523	252	1
MS20-0.25	0.16 ... 0.25	-	30.108.524	252	1
MS20-0.4	0.25 ... 0.4	-	30.108.525	252	1
MS20-0.63	0.4 ... 0.63	-	30.108.526	252	1
MS20-1	0.63 ... 1	0.06 ... 0.09	30.108.527	252	1
MS20-1.6	1 ... 1.6	0.12	30.108.528	252	1
MS20-2.5	1.6 ... 2.5	0.18 ... 0.25	30.108.529	252	1
MS20-4	2.5 ... 4	0.37	30.108.513	252	1
MS20-6.3	4 ... 6.3	0.55 ... 0.75	30.108.514	252	1
MS20-10	6.3 ... 10	1.1 ... 1.5	30.108.515	252	1
MS20-16	10 ... 16	2.2	30.108.516	252	1
MS20-20	16 ... 20	3	30.108.517	252	1



### Motor protection circuit breakers MST25

With overload release, AC-3 acc. to IEC/EN 60947-4-1

Type	Setting range (A)	Motor power (3-phase, 400 V) (kW)	Ordering No.	Weight (g)	Packaging (pcs)
MST25-0.4	0.25 ... 0.4	0.09	30.108.240	252	1
MST25-0.63	0.4 ... 0.63	0.12	30.108.241	252	1
MST25-1	0.63 ... 1	0.18 ... 0.25	30.108.242	252	1
MST25-1.6	1 ... 1.6	0.37 ... 0.55	30.108.243	252	1
MST25-2.5	1.6 ... 2.5	0.75 ... 1.1	30.108.244	252	1
MST25-4	2.5 ... 4	1.1 ... 1.5	30.108.245	252	1
MST25-6.3	4 ... 6.3	2.2 ... 2.5	30.108.246	252	1
MST25-10	6.3 ... 10	3 ... 4	30.108.247	252	1
MST25-16	10 ... 16	5 ... 7.5	30.108.248	252	1
MST25-20	16 ... 20	9	30.108.249	252	1
MST25-25	20 ... 25	11 ... 12.5	30.108.250	252	1
MST25-32	25 ... 32	15	30.109.476	252	1



**Circuit breakers for thermistor-protected motors MPE**

With overload and short-circuit release, AC-3 acc. to IEC/EN 60947-4-1

Type	Setting range (A)	Motor power (3-phase, 400 V) (kW)	Ordering No.	Weight (g)	Packaging (pcs)
MPE	0.25	0.06	30.107.879	252	1



**Circuit breakers for short-circuit protection MSZ25 with short-circuit release**

Type	Setting range (A)	Motor power (3-phase, 400 V) (kW)	Ordering No.	Weight (g)	Packaging (pcs)
MSZ25-0.16	-	0.02	30.109.357	252	1
MSZ25-0.25	-	0.06	30.109.358	252	1



**Circuit breakers for transformer protection MS25TR**

With overload and short-circuit release, AC-6a acc. to IEC/EN 60947-4-1

Type	Setting range (A)	Ordering No.	Weight (g)	Packaging (pcs)
MS25TR-0.16	0.1 ... 0.16	30.109.477	252	1
MS25TR-0.25	0.16 ... 0.25	30.109.478	252	1
MS25TR-0.4	0.25 ... 0.4	30.109.479	252	1
MS25TR-0.63	0.4 ... 0.63	30.109.480	252	1
MS25TR-1	0.63 ... 1	30.109.481	252	1
MS25TR-1.6	1 ... 1.6	30.109.482	252	1
MS25TR-2.5	1.6 ... 2.5	30.109.368	252	1
MS25TR-4	2.5 ... 4	30.109.369	252	1
MS25TR-6.3	4 ... 6.3	30.109.370	252	1
MS25TR-10	6.3 ... 10	30.109.371	252	1
MS25TR-16	10 ... 16	30.109.372	252	1
MS25TR-20	16 ... 20	30.109.373	252	1
MS25TR-25	20 ... 25	30.109.374	252	1
MS25TR-32	25 ... 32	30.109.483	252	1



**Ordering data**



**Example:**

The same switch with under-voltage release for control voltage 380 V with an auxiliary switch with two NO contacts, built in the enclosure, with an emergency stop push-button and green signal lamp for 230 V: **MS25 - 4 / U 380 / PS 20 / 041 / NAT / SSz 230**

### Tripping characteristics

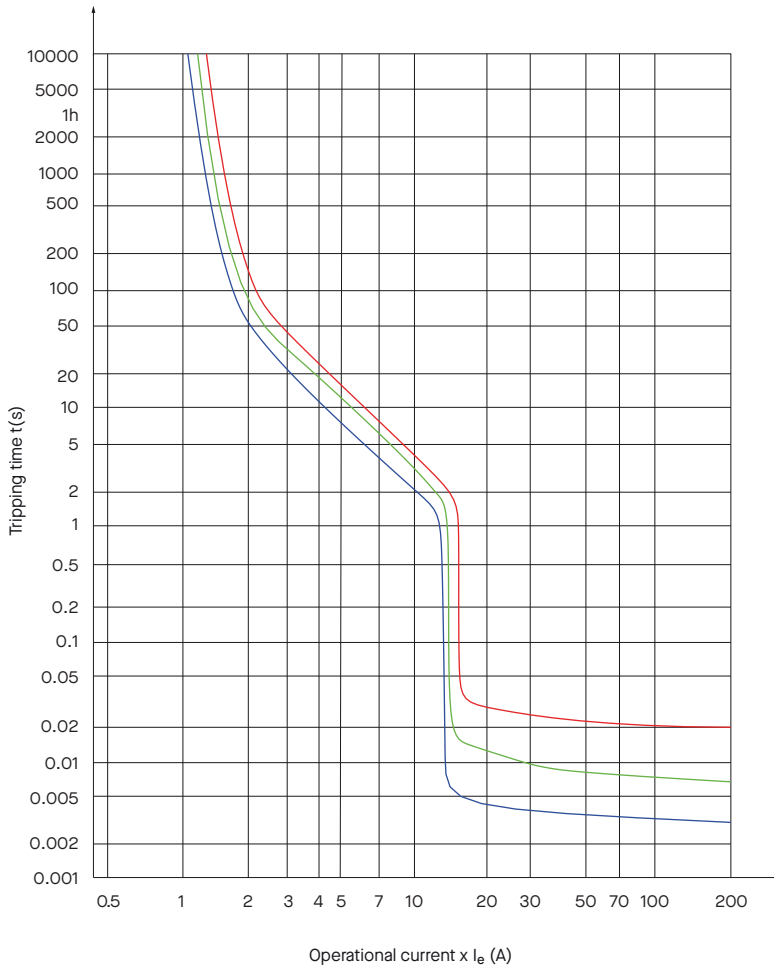

### Dimensions (mm)

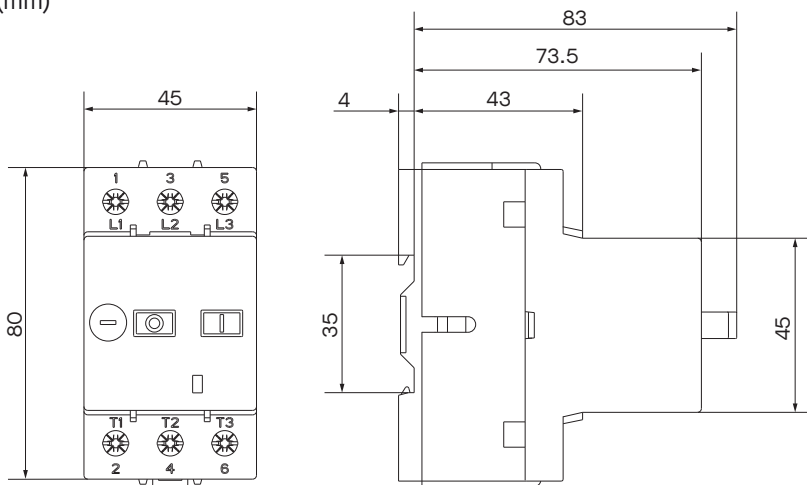

# Accessories for MS25

## Auxiliary switch for lateral mounting PS

Type	Symbol	Unit	PS
Standards			IEC 60947-5-1, UL 60947-5-1
Approvals			CE, UL, EAC
Rated impulse voltage	$U_{imp}$	kV	6
Rated insulation voltage	$U_i$	V	500
Thermal current	$I_{th}$	A	6
<b>Rated operational current AC-15</b>			
230 V	$I_e$	A	3.5
400 V			2
500 V			1.5
Mechanical endurance		op. c.	100.000
Terminal capacity	S	mm <sup>2</sup>	0.75 ... 2.5
Conductor insulation stripping length		mm	8
Screw type			M3.5
Screw head			PZ2
Tightening torque		Nm	1

## Trip-indicating auxiliary switch RS

Type	Symbol	Unit	RS
Standards			IEC 60947-5-1, UL 60947-5-1
Approvals			CE, UL, EAC
Rated impulse voltage	$U_{imp}$	kV	6
Rated insulation voltage	$U_i$	V	500
Thermal current	$I_{th}$	A	6
<b>Rated operational current AC-15</b>			
230 V	$I_e$	A	1.5
400 V			1.5
500 V			1.5
Mechanical endurance		op. c.	100.000

## Under-voltage release U, Shunt release A

Type	Symbol	Unit	U, A
Standards			IEC 60947-5-1, UL 60947-5-1
Approvals			CE, UL, EAC
Control voltages (AC)	$U_c$	V	24, 48, 110, 120, 230, 400, 415, 480, 500, 600
Rated frequency	f	Hz	50/60
Pick-up voltage		$\times U_c$	$\leq 0.85$
Drop-out voltage			0.7 ... 0.35
<b>Power consumption switch-on operation</b>			
switch-on		VA/W	7.5 / 4.3
operation			3.8 / 1.3
Duty cycle	$t_{on}/t_{off}$	%	100
Noise level		dB	$\leq 35$
Mechanical and electrical endurance		op. c.	100.000



**Auxiliary contact block for lateral mounting PS**

Type	Number of contacts		Wiring diagram	Ordering No.	Weight (g)	Quantity / Box
	NO	NC				
PS01	0	1		38.901.670	35	1
PS10	1	0		38.901.669	35	1
PS11	1	1		38.901.501	35	1
PS20	2	0		38.901.500	35	1

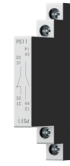

**Under-voltage release U**

Voltage (V)*	Frequency (Hz)	Ordering No.	Weight (g)	Quantity / Box
24	50/60	38.901.502	62	1
24	60	38.901.952	62	1
48	50	38.901.904	62	1
48	60	38.902.956	62	1
60	50	38.901.504	62	1
110	50	38.901.505	62	1
120	60	38.903.035	62	1
120	50	38.903.035	62	1
220 - 240	50	38.901.506	62	1
240	60	38.901.506	62	1
380 - 415	50	38.901.508	62	1
440	60	38.901.508	62	1
415	60	38.902.964	62	1
480	50	38.902.966	62	1
480	60	38.901.863	62	1
500	50	38.902.968	62	1
500	60	38.902.970	62	1
600	50	38.902.972	62	1
600	60	38.901.870	62	1



\* U release for other control voltage/frequencies are on request.

**Accessories for enclosures O-41/55 and CP-41/55**

Type	Voltage	Ordering No.	Weight (g)	Quantity / Box
Emergency stop push-button <b>NAT</b>	/	38.901.665	40	1
Emergency stop push-button with keylock <b>NAT-K</b>	/	38.902.488	40	1
Padlocking feature <b>Z</b>	/	38.901.632	95	1
Push-button diaphragm <b>IP55</b>	/	38.422.130	12	1
Neutral link <b>NL</b>	/	38.552.076	525	25
Signal lamp <b>SSr (Red)</b>	250 V 400 V	623.000.131 623.009.261	175	25
Signal lamp <b>SSr (Green)</b>	250 V 400 V	623.009.257 623.009.262	175	25
Signal lamp <b>SSb (Transparent)</b>	250 V 400 V	623.009.256 623.009.263	175	25
Cable inlet <b>M25 x 1.5</b>	/	315.609.520	15	100

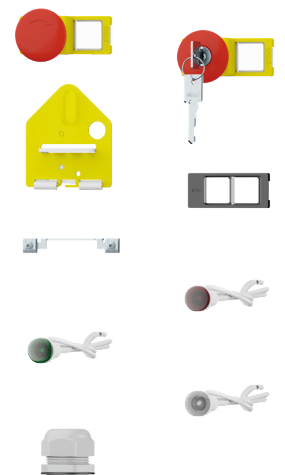

**Shunt release A**

Voltage (V)*	Frequency (Hz)	Ordering No.	Weight (g)	Quantity / Box
24	50/60	38.901.510	62	1
24	60	38.901.953	62	1
48	50	38.901.905	62	1
48	60	38.902.957	62	1
60	50	38.901.504	62	1
110	50	38.901.513	62	1
120	60	38.901.727	62	1
220 - 240	50	38.901.514	62	1
240	60	38.901.516	62	1
380 - 415	50	38.901.516	62	1
440	60	38.901.516	62	1
415	60	38.902.965	62	1
480	50	38.902.967	62	1
480	60	38.901.864	62	1
500	50	38.902.969	62	1
500	60	38.902.971	62	1
600	50	38.902.973	62	1
600	60	38.901.872	62	1



\* A releases for other control voltage/frequencies are on request.

**Trip-indicating auxiliary contact block RS**

Type	Number of contacts		Wiring diagram	Ordering No.	Weight (g)	Quantity / Box
	NO	NC				
RS01	0	1		38.902.149	35	1
RS10	1	0		38.902.150	35	1



Note: RS contact changes position from its normal state when the MS25 MPCB trips due to overload, short-circuit or the manual depression of the TEST lever.

**Adapters for connection of MS25 with a contactor**

Type	Conductor length (mm)	Conductor cross-section (mm <sup>2</sup> )	Thermal current (A)	Ordering No.	Weight (g)	Quantity / Box
DST-U-2.5	40	2.5	20	665.200.020	12	10
DST-U-4	40	4	35	665.200.021	16	10
DST-U-2.5 L	70	2.5	20	665.200.022	14	10



**Enclosures for MS25**

Type	Degree of protection	Ordering No.	Weight (g)	Quantity / Box
<b>Enclosures</b>				
O-41	IP41	38.422.509	222	1
O-55	IP55	38.422.510	222	1
<b>Front Plates</b>				
CP-41	IP41	38.422.035	150	1
CP-55	IP55	38.421.994	150	1

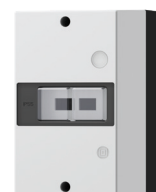

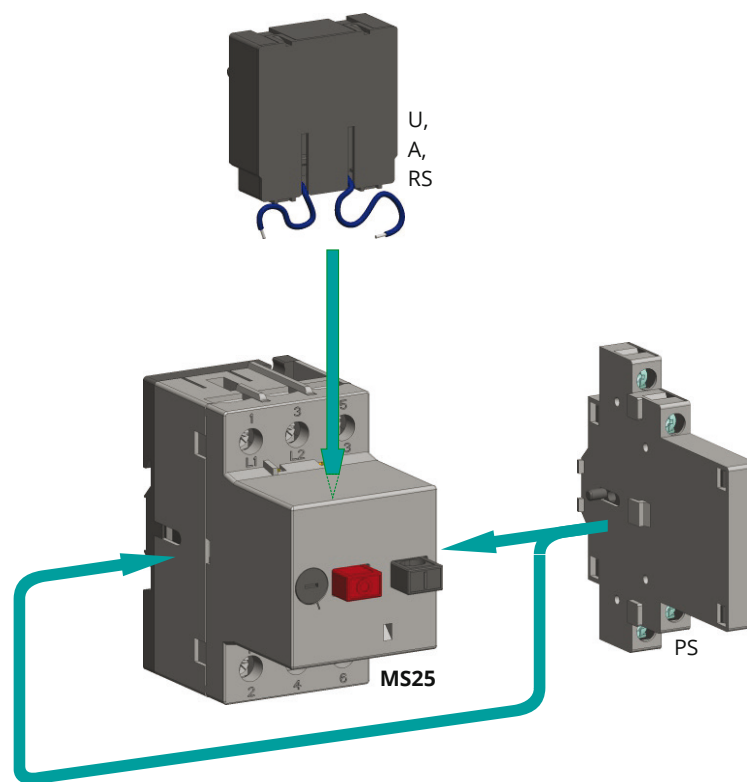
**Mounting positions of accessories**

### Dimensions

(mm)

#### Auxiliary switch PS

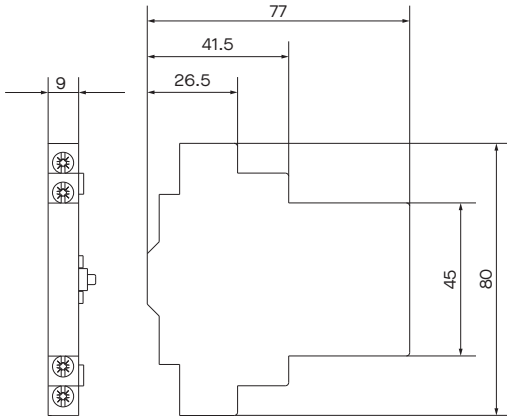

#### CP-41/55

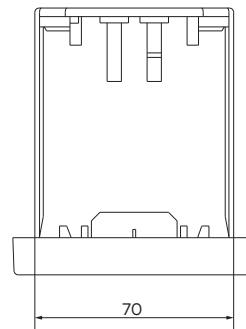
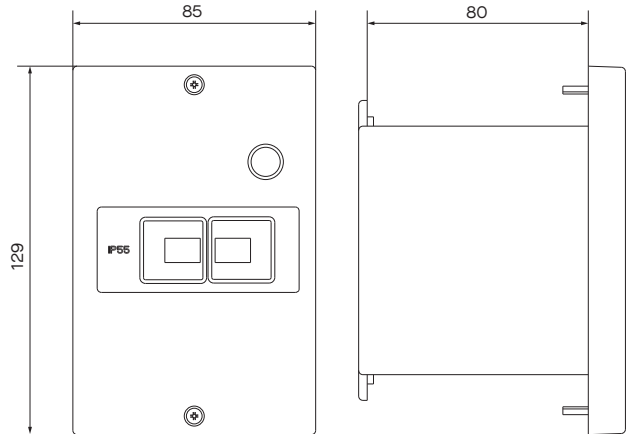

#### O-41/55

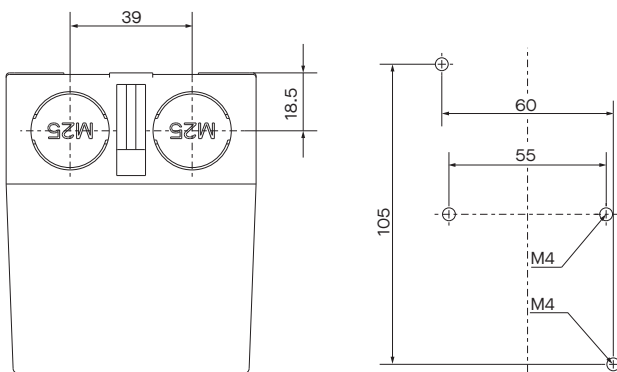
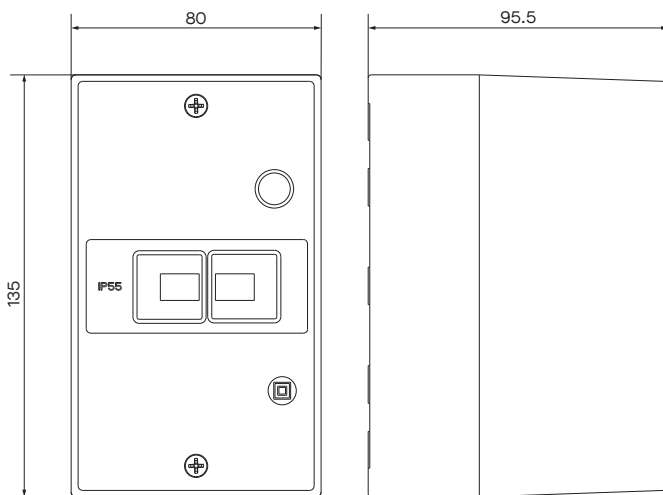

# MS32

## motor protection circuit breakers

Motor protection circuit breakers are special type of circuit breakers designed for protection of wide range of single-phase and three-phase ac motors against overload and short circuit. They are used in industry, small machines, agricultural machines, compressors etc.

### For motor protection

- ▶ All kind of AC induction motors
- ▶ For three-phase motors up to 22 kW

### Protection of other loads

- ▶ Various low-inductive loads
- ▶ Version for transformer protection MS32TR

### Other Benefits

- ▶ Manual control:
  - START, STOP, push-buttons - with a trip indication (i.e. push-buttons stay in the middle position)
- ▶ Automatic switch-off at over-current with thermal or magnetic release
- ▶ Control with under-voltage release or shunt release
- ▶ An auxiliary switch for side mounting or flush mounting used for indication of the switching state
- ▶ Indication of release with trip indicating auxiliary switch
- ▶ ON/OFF buttons positions unequivocally indicates switching position of main contacts
- ▶ Contact material :
  - resistant to contact welding
  - enables low contact heating
- ▶ Isolating distance between contacts: 4.5 mm per contact place
- ▶ Connection of a rigid or flexible conductor
- ▶ Assembly to 35 mm wide mounting rail in compliance with EN 60715
- ▶ Vertical or horizontal operational position

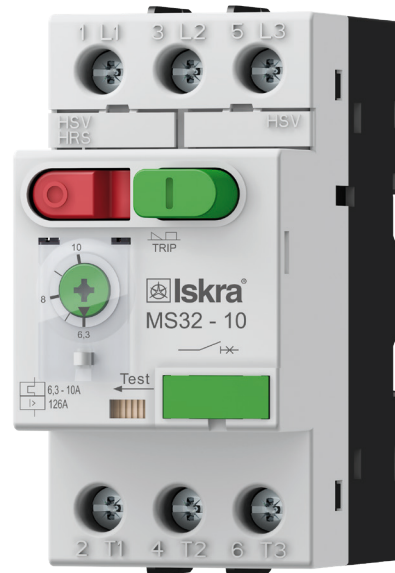

**MS32 characteristics**

Technical data	Symbol	Unit	MS32
<b>General</b>			
Area of use			motor protection
Standards			IEC/EN 60947-2, IEC/EN 60947-4-1, IEC/EN 60204, UL 60947, CSA 22.2 No. 14
Approvals			CE, UL, CSA, EAC
Climatic class			Constant damp heat acc. to IEC 60068-2-78 Cyclic damp heat acc. to IEC 60068-2-30
Degree of protection			IP20, after terminals covering IP40
Mounting			35 mm DIN rail (EN 60715)
Mounting position			any
Ambient temperature		°C	-25 ... +60
Storage temperature		°C	-25 ... +70
Temperature range of thermal compensation		°C	-5 ... +40
Maximum altitude (MSL)*		m	2000
Mechanical endurance		op. c.	100.000
Electrical endurance		op. c.	100.000 (AC-3), 20.000 (DC-5)
Trip class acc. to IEC 60947-4-1			10
Utilization category acc. to IEC 60947-4-1			AC-3
Utilization category acc. to IEC 60947-2			A
Max. switching frequency		op. c./h	25
Shock resistance acc. to IEC 68-2-27		g	20
Vibration resistance acc. to IEC 68-2-6		g	5 (at f= 5 ... 150 Hz)
Overvoltage category			III
Pollution degree			3
Rated insulation voltage	$U_i$	V	690
Rated impulse withstand voltage	$U_{imp}$	kV	6
Weight		g	279
<b>Main circuit</b>			
<b>Terminal capacity</b>			
			rigid (solid and stranded) 1 ... 10
			flexible 1 ... 6
			flexible with end sleeve 0.75 ... 6
Conductor insulation stripping length		mm	10
Screw			M3
Screw type			PZ2, with self-lifting clamp protected from falling out
Tightening torque		Nm	2.0
Nominal current	$I_n$	A	0.16, 0.25, 0.4, 0.63, 1, 1.6, 2.5, 6.3, 10, 14, 18, 23, 27, 32
Current setting	$I_T$	A	0.1-0.16, 0.16-0.25, 0.25-0.4, 0.4-0.63, 0.63-1, 1-1.6, 1.6-2.5, 2.4-4, 4-6.3, 6.3-10, 9-14, 13-18, 17-23, 20-27, 25-32
Nominal current range	$I_n$	A	0.16 ... 32
Nominal frequency	$f$	Hz	50/60
Max. operational voltage	$U_e$	V	690
Thermal current	$I_{th}$	A	32
Max. motor current AC-3		A	32
Number of all poles			3
Number of protected poles			3
Contact gap (per pole)		mm	9.2
Release type			thermal-magnetic
Operating current of thermal overload release			$1.05 I_r < I < 1.2 I_r$
Operating current of magnetic release (fixed)			$12 I_n \pm 20 \%$
Sensitivity to phase failure			yes
Power dissipation at $I_n$ (all poles)		W	6 ... 7.5

\* Above 2000 m voltages  $U_i$  and  $U_e$  are reduced by 2% for every 100 m and current  $I_e$  by 2% for every 500 m.

**Motor protection circuit-breakers areas of use**

Type	Motor protection	Overload protection	Short-circuit protection	Single-phase consumers	Transformer protection
MS18	•	•	•	•	
MS32	•	•	•	•	
MS32TR		•	•		•

**MS32 characteristics**

Technical data	Symbol	Unit	MS32
<b>Safety</b>			
MTTF - Mean time to failure $MTTF = 1/\lambda = B10/(0.1 n_{op})$		h	1666
MTTF <sub>d</sub> - Mean time to failure dangerous $MTTF_d = 1/\lambda = B10_d/(0.1 n_{op})$		h	5000
B10 - Number of operating cycles until 10 % of devices fail		op. c.	20.000
B10 <sub>d</sub> - Number of operating cycles until 10 % of devices dangerous $B10_d = B10/\text{ratio of dangerous failures}$		op.c.	60.000
$\lambda$ - Failure rate $\lambda = (0.1 n_{op}) / B10$		1 / h	$6 \times 10$
$\lambda_d$ - Failure rate $\lambda_d = (0.1 n_{op}) / B10_d$		1 / h	$2 \times 10$
Ratio of dangerous failures		%	33
$n_{op}$ - Operating cycles (operating cycles/h)		op. c. / h	120

**Switch selection for motor protection**

Single-phase	Standard motor powers					Settings range
	Three-phase					
220 V 230 V 240 V	220 V 230 V 240 V	380 V 400 V 415 V	440 V	550 V	660 V 690 V	
kW						A
					0.06	0.1 ... 0.16
		0.06	0.06	0.06 ... 0.9	0.06 ... 0.12	0.16 ... 0.25
	0.06	0.09	0.12	0.09 ... 0.12	0.18	0.25 ... 0.4
	0.09	0.12 ... 0.18	0.18	0.18	0.25	0.4 ... 0.63
0.06 ... 0.09	0.09 ... 0.12	0.18 ... 0.25	0.25 ... 0.37	0.25 ... 0.37	0.37 ... 0.55	0.63 ... 1
0.12	0.18 ... 0.25	0.37 ... 0.55	0.37 ... 0.55	0.55 ... 0.75	0.75 ... 1.1	1 ... 1.6
0.18 ... 0.25	0.37	0.75	0.75 ... 1.1	1.1	1.5	1.6 ... 2.5
0.37	0.55 ... 0.75	1.1 ... 1.5	1.5	1.5 ... 2.2	2.2 ... 3	2.5 ... 4
0.55 ... 0.75	1.1 ... 1.5	2.2	2.2 ... 3	2.2 ... 3	4	4 ... 6.3
1.1 ... 1.5	1.5 ... 2.2	3 ... 4	4	4 ... 5.5	5.5 ... 7.5	6.3 ... 10
2.2	2.2 ... 3	5.5	5.5 ... 7.5	5.5 ... 7.5	9 ... 11	9 ... 14
3	4	7.5	7.5 ... 9	9 ... 11	15	13 ... 18
	5.5	9 ... 11	11	11	15 ... 18.5	17 ... 23
	5.5 ... 7.5	11	11	15	18.5 ... 22	20 ... 27
	7.5	15	15	18.5	22	25 ... 32

### MS32 motor protection switches

Rated ultimate and service short-circuit breaking capacity  $I_{cu}$  and  $I_{cs}$  and max. back-up fuses if short circuit current  $I_{cp}$  exceeds  $I_{cu}$

Type	Operating current of short-circuit release (A)	Rated ultimate short-circuit breaking capacity $I_{cu}$ , $I_{cs}$ (kA)								Max. back-up fuse, if $I_{cp} > I_{cu}$ (gL) (A)				
		230 V		400 V		500 V		690 V		230 V	400 V	500 V	690 V	
		$I_{cu}$	$I_{cs}$	$I_{cu}$	$I_{cs}$	$I_{cu}$	$I_{cs}$	$I_{cu}$	$I_{cs}$					
MS32-0.16	2	100	100	100	100	100	100	100	100	No back-up fuse required				
MS32-0.25	3	100	100	100	100	100	100	100	100					
MS32-0.4	5	100	100	100	100	100	100	100	100					
MS32-0.63	8	100	100	100	100	100	100	100	100					
MS32-1	13	100	100	100	100	100	100	100	100					
MS32-1.6	22	100	100	100	100	100	100	100	100					
MS32-2.5	33	100	100	100	100	100	100	5	5					16
MS32-4	55	100	100	100	100	100	100	3	3					25
MS32-6.3	75	100	100	100	100	6	4.5	3	2				35	35
MS32-10	126	100	100	100	100	6	4.5	3	2				50	35
MS32-14	170	25	12.5	25	12.5	6	4.5	3	2	80	63	50	50	
MS32-18	230	25	12.5	25	12.5	6	4.5	3	2	80	63	50	50	
MS32-23	270	25	12.5	25	12.5	4	3	3	2	80	63	50	50	
MS32-27	360	25	12.5	25	12.5	4	3	3	2	80	63	50	50	
MS32-32	400	25	12.5	25	12.5	4	3	3	2	80	63	50	50	

### MS32 characteristics

Type	Setting range (A)	Motor power (3-phase, 400 V) (kW)	Ordering No.	Weight (g)	Quantity / Box
MS32-0.16	0.1 ... 0.16		30.108.757	279	1
MS32-0.25	0.16 ... 0.25	0.06	30.108.758	279	1
MS32-0.4	0.25 ... 0.4	0.09	30.108.759	279	1
MS32-0.63	0.4 ... 0.63	0.12 ... 0.18	30.108.760	279	1
MS32-1	0.63 ... 1	0.18 ... 0.25	30.108.761	279	1
MS32-1.6	1 ... 1.6	0.37 ... 0.55	30.108.762	279	1
MS32-2.5	1.6 ... 2.5	0.75	30.108.763	279	1
MS32-4	2.5 ... 4	1.1 ... 1.5	30.108.764	279	1
MS32-6.3	4 ... 6.3	2.2	30.108.765	279	1
MS32-10	6.3 ... 10	3 ... 4	30.108.766	279	1
MS32-14	9 ... 14	5.5	30.108.767	279	1
MS32-18	13 ... 18	7.5	30.108.768	279	1
MS32-23	17 ... 23	9 ... 11	30.108.769	279	1
MS32-27	23 ... 27	11	30.108.770	279	1
MS32-32	25 ... 32	15	30.108.771	279	1





**Circuit breakers for transformer protection MS32TR**

With overload and short-circuit release, AC-3 acc. to IEC/EN 60947-4-1

Type	Setting range (A)	Ordering No.	Weight (g)	Packaging (pcs)
MS32TR-2.5	1.6 ... 2.5	30.109.359	279	1
MS32TR-4	2.5 ... 4	30.109.360	279	1
MS32TR-6.3	4 ... 6.3	30.109.361	279	1
MS32TR-10	6.3 ... 10	30.109.362	279	1
MS32TR-14	9 ... 14	30.109.363	279	1
MS32TR-18	13 ... 18	30.109.364	279	1
MS32TR-23	17 ... 23	30.109.365	279	1
MS32TR-27	23 ... 27	30.109.366	279	1
MS32TR-32	25 ... 32	30.109.367	279	1



**Ordering data**

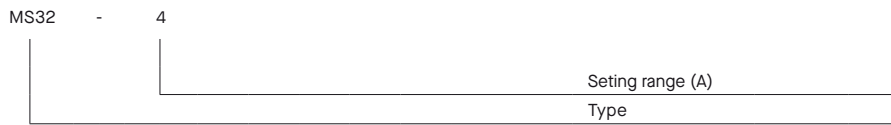

**Example:**

The same switch with under-voltage release for control voltage 380 V with an auxiliary switch with two NO contacts, built in the enclosure, with an emergency stop push-button and green signal lamp for 230 V: **MS32 - 4 / UR 380 / HS 20 / HO41 / NAT / SSz 230**

### Tripping characteristics

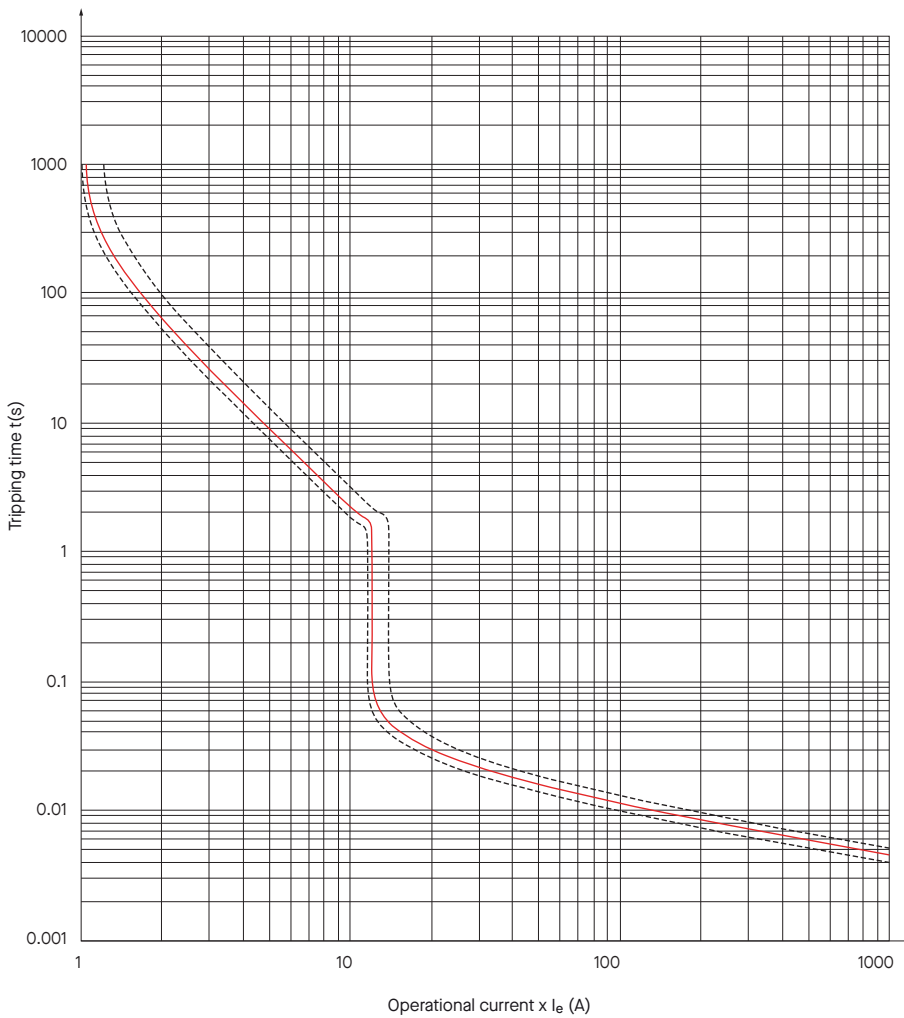

### Dimensions

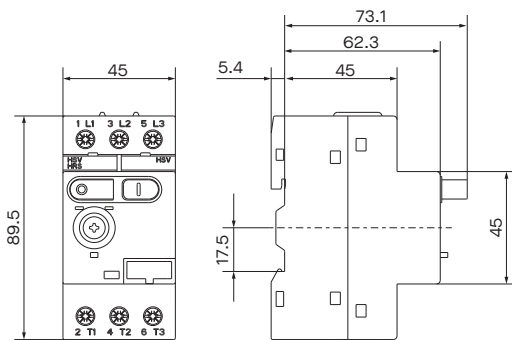

(mm)



# Accessories for MS32

## Auxiliary contact block HSV

AC-15, DC-13 acc. to IEC/EN 60947-5-1



Type	Number of contacts		Wiring diagram	Ordering No.	Weight (g)	Quantity / Box
	NO	NC				
HSV10	1	0		38.902.521	32	1
HSV01	0	1		38.902.520	32	1



Note: HSV contact changes position from its normal state when the MS32 MPCB is switched on.

## Trip-indicating contact block HRS

AC-15, DC-13 acc. to IEC/EN 60947-5-1



Type	Number of contacts		Wiring diagram	Ordering No.	Weight (g)	Quantity / Box
	NO	NC				
HRS10	1	0		38.902.523	32	1
HRS01	0	1		38.902.522	32	1



Note: HRS contact changes position from its normal state when the MS32/MS18 MPCB trips due to overload, short-circuit or manual depression of the TEST lever.

## Auxiliary contact block for lateral mounting HS

AC-15, DC-13 acc. to IEC/EN 60947-5-1

Type	Number of contacts		Wiring diagram	Ordering No.	Weight (g)	Quantity / Box
	NO	NC				
HS10	1	0		38.902.456	32	1
HS11	1	1		38.902.458	32	1
HS20	2	0		38.902.460	32	1



**Auxiliary switch for side mounting HS characteristics**

Type	Symbol	Unit	HS
Standards			IEC 60947-5-1, UL 60947-5-1
Approvals			CE, UL, EAC
Rated impulse voltage	$U_{imp}$	V	6 kV
Rated insulation voltage	$U_i$	V	500
Thermal current	$I_{th}$	A	5
Rated operational current AC-15 (240 V)	$I_e$	A	1.5
Rated operational current DC-13 (250 V)	$I_e$	A	0.1
Contact rating code designation for AC/DC			B300 / R300
Mechanical endurance		op. c.	100.000
Electrical endurance		op. c.	100.000
Terminal capacity	S	mm <sup>2</sup>	0.75 ... 2.5
Conductor insulation stripping length		mm	8
Screw type			M3.5
Screw head			PZ2
Tightening torque		Nm	1

**Auxiliary contact block HSV and Trip indicating contact block HRS characteristics**

Type	Symbol	Unit	HSV, HRS
Standards			IEC 60947-5-1, UL 60947-5-1
Approvals			CE, UL, EAC
Rated impulse voltage	$U_{imp}$	V	6
Rated insulation voltage	$U_i$	V	300
Thermal current	$I_{th}$	A	1
Rated operational current AC-15 (240 V)	$I_e$	A	3
Rated operational current DC-13 (125 V)	$I_e$	A	0.22
Contact rating code designation for AC/DC			B300 / R300
Mechanical endurance		op. c.	100.000
Electrical endurance		op. c.	100.000
Terminal capacity	S	mm <sup>2</sup>	0.75 ... 2.5
Conductor insulation stripping length		mm	8
Screw type			M3.5
Screw head			PZ2
Tightening torque		Nm	0.6

**Under-voltage release UR**

Voltage (V)*	Frequency (Hz)	Ordering No.	Weight (g)	Quantity / Box
24	50	38.902.534	62	1
24	60	38.902.535	62	1
110	50	38.902.941	62	1
110	60	38.902.536	62	1
230	50	38.902.461	62	1
230	60	38.902.943	62	1
240	50	38.902.524	62	1
240	60	38.902.537	62	1
400	50	38.902.634	62	1
400	60	38.902.947	62	1
415	50	38.902.533	62	1
415	60	38.902.949	62	1
480	50	38.902.951	62	1
480	60	38.902.538	62	1
500	50	38.902.952	62	1
500	60	38.902.939	62	1
600	50	38.902.954	62	1
600	60	38.902.539	62	1

\* UR release for other control voltage/frequencies are on request.

**Shunt release AR**

Voltage (V)*	Frequency (Hz)	Ordering No.	Weight (g)	Quantity / Box
24	50	38.902.574	62	1
24	60	38.902.575	62	1
110	50	38.902.940	62	1
110	60	38.902.576	62	1
230	50	38.902.462	62	1
230	60	38.902.942	62	1
240	50	38.902.525	62	1
240	60	38.902.944	62	1
400	50	38.902.945	62	1
400	60	38.902.946	62	1
415	50	38.902.573	62	1
415	60	38.902.948	62	1
480	50	38.902.950	62	1
480	60	38.902.578	62	1
500	50	38.902.579	62	1
500	60	38.902.938	62	1
600	50	38.902.953	62	1
600	60	38.902.955	62	1

\* AR release for other control voltage/frequencies are on request.

**Under-voltage release UR and Shunt release AR characteristics**

Type	Symbol	Unit	UR, AR
Standards			IEC 60947-5-1, UL 60947-5-1
Approvals	$U_c$	V	CE, UL, EAC
Control voltages (AC)	$U_c$	V	24, 110, 230, 240, 400, 415, 480, 500, 600
Rated frequency	$f$	Hz	50 / 60
Pick-up voltage	$x U_c$		< 0.85                      ≤ 0.7
Drop-out voltage			0.7 ... 0.35                      0.7 ... 0.15
Power consumption switch-on operation		VA / W	switch-on: 7.9 / 3.9 operation: 3.3 / 0.9
Duty cycle	$t_{ON} / t_{OFF}$	%	100
Noise level		dB	≤35
Mechanical and electrical endurance		op.	min. 10.000
Terminal capacity		mm <sup>2</sup>	0.75 ... 2.5
Conductor insulation stripping length		mm	11
Screw type			M3.5
Screw head			PZ2
Tightening torque		Nm	1



**Adapters for connection of MS32 with a contactor**

Type	Used for	Ordering No.	Weight (g)	Quantity / Box
MSK07	K07	30.018.211	10	10
MSKNL9	KNL9 ... KNL18	30.018.212	10	10
MSKNL22	KNL22 ... KNL30	30.018.213	10	10



**Connection blocks MSS-3L**

Type	Number of MPCB	Length (mm)	Ordering No.	Weight (g)	Quantity / Box
MSS-3L-M2-45	2	80	655.200.001	26	10
MSS-3L-M3-45	3	125	655.200.002	48	10
MSS-3L-M4-45	4	170	655.200.003	68	10
MSS-3L-M5-45	5	215	655.200.004	90	10
MSS-3L-M2 + Hi-45 + 9	2	90	655.200.005	30	10
MSS-3L-M3 + Hi-45 + 9	3	145	655.200.006	54	10
MSS-3L-M4 + Hi-45 + 9	4	200	655.200.007	78	10
MSS-3L-M5 + Hi-45 + 9	5	250	655.200.008	111	10



**MSS-3L-MX-45 connection blocks**

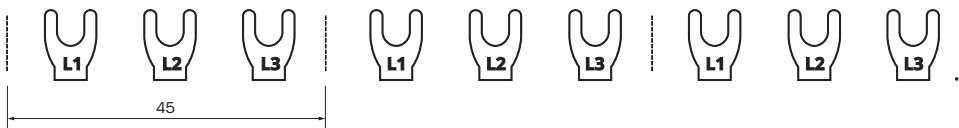

**MSS-3L-MX-45 + 9 connection blocks  
(for MPCB with side-mounted accessories)**



**Supply block (25 mm<sup>2</sup>)**

Type	Ordering No.	Weight (g)	Quantity / Box
ESB-S/V-MS	655.200.009	40	10

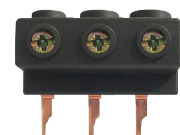

**Protection for connection cable**

Type	Ordering No.	Weight (g)	Quantity / Box
BS-MS 0	655.200.010	2	10



**Enclosures for MS32**

Type	Degree of protection	Ordering No.	Weight (g)	Quantity / Box
<b>Enclosures</b>				
HO-41	IP41	38.423.019	222	1
HO-55	IP55	38.423.020	222	1
<b>Frames</b>				
FP-41	IP41	38.423.111	158	1
FP-55	IP55	38.423.112	158	1
<b>Front Plates</b>				
P-41	IP41	37.425.102	200	1
P-55	IP55	38.423.137	200	1



**Accessories for enclosures HO-41/55, FP-41/55, P-41/55**

Type	Voltage	Ordering No.	Weight (g)	Quantity / Box
Emergency stop push-button <b>E</b>	/	38.902.528	40	1
Emergency stop push-button with keylock <b>E-K</b>	/	38.902.530	40	1
Padlocking feature <b>HZ</b>	/	38.423.095	95	1
Push-button diaphragm <b>IP55</b>	/	38.423.113	12	1
Neutral link <b>NL</b>	/	38.552.076	525	25
Signal lamp <b>SSr (Red)</b>	250 V 400 V	623.000.131 623.009.261	175	25
Signal lamp <b>SSr (Green)</b>	250 V 400 V	623.009.257 623.009.262	175	25
Signal lamp <b>SSb (Transparent)</b>	250 V 400 V	623.009.256 623.009.263	175	25
Cable inlet <b>M25 x 1.5</b>	/	315.609.520	15	100



### Mounting positions of accessories

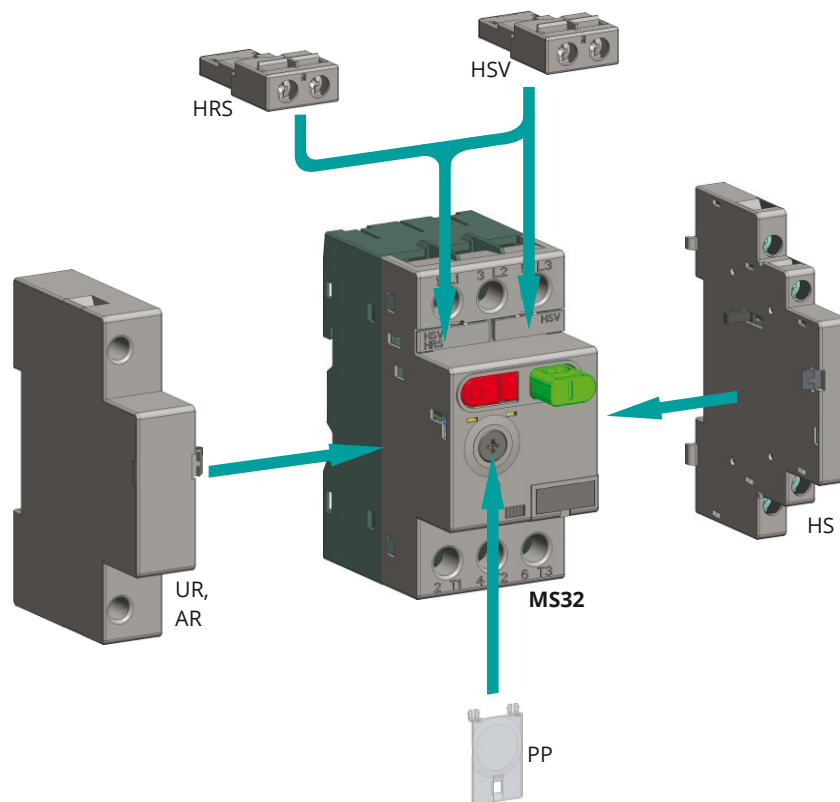



### Connection blocks

MSK07, MSKNL9 and MSKNL22 adapters are used for connecting a motor protection switch with a contactor forming a single-unit starter for quick assembly to a 35 mm wide mounting rail (EN 60715)

- ▶ MSK07 - Adapter for connecting MS32 motor protection switch with K07 mini contactor
- ▶ MSKNL9 - Adapter for connecting MS32 motor protection switch with KNL9-KNL18 contactor
- ▶ MSKNL22 - Adapter for connecting MS32 motor protection switch with KNL22, KNL30 contactor

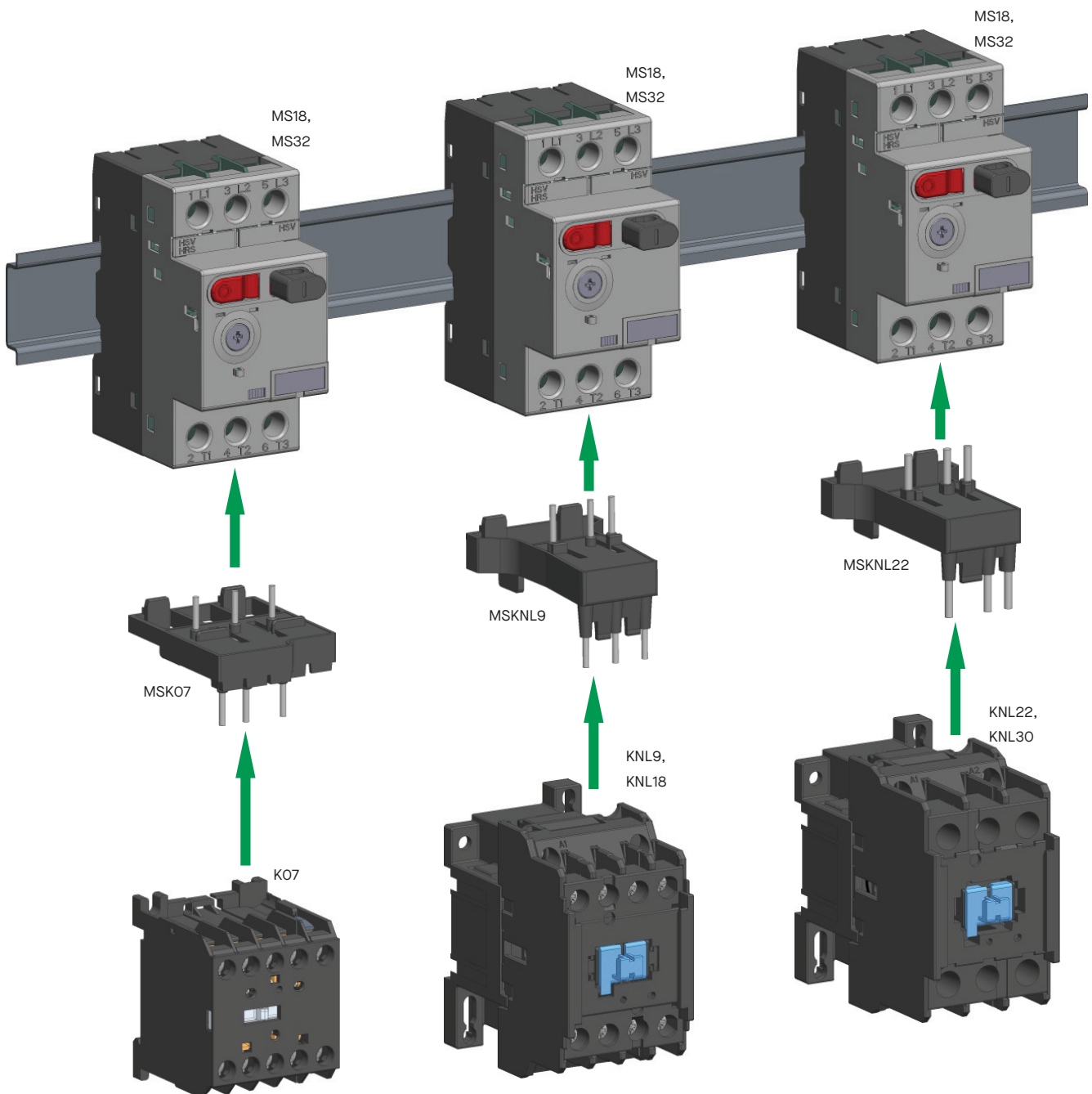

## Dimensions

(mm)

### Auxiliary switch HS

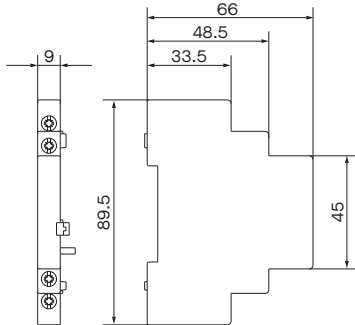

### Under-voltage release UR Shunt release AR

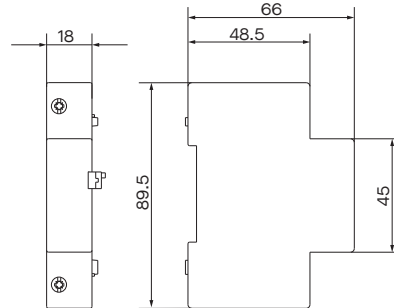

### FP-41/55

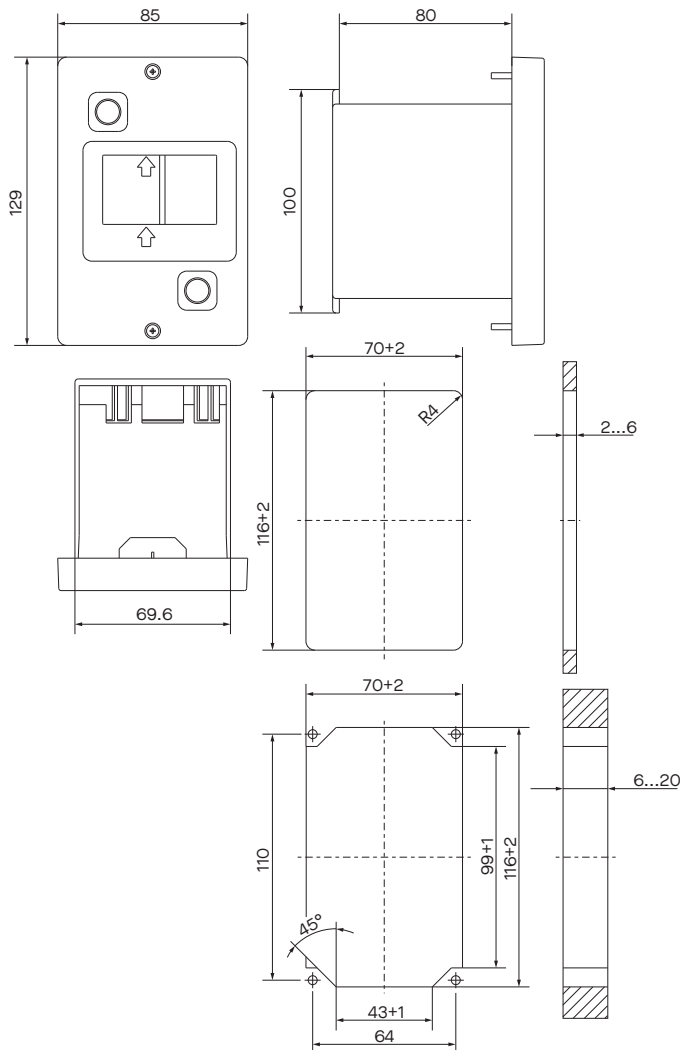

### HO-41/55

